

State-of-the-Art Fabrication?

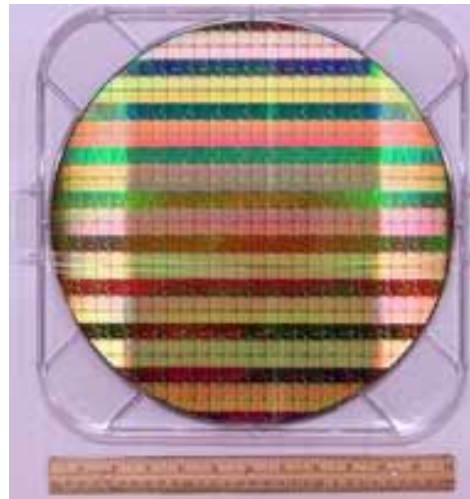

State-of-the-Art Fabrication!

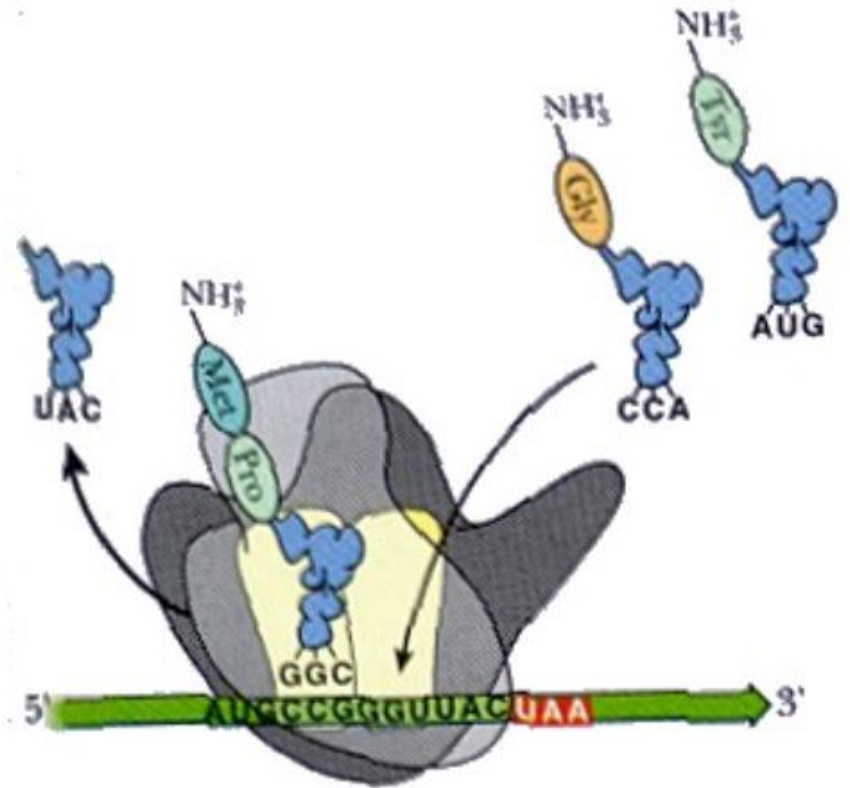
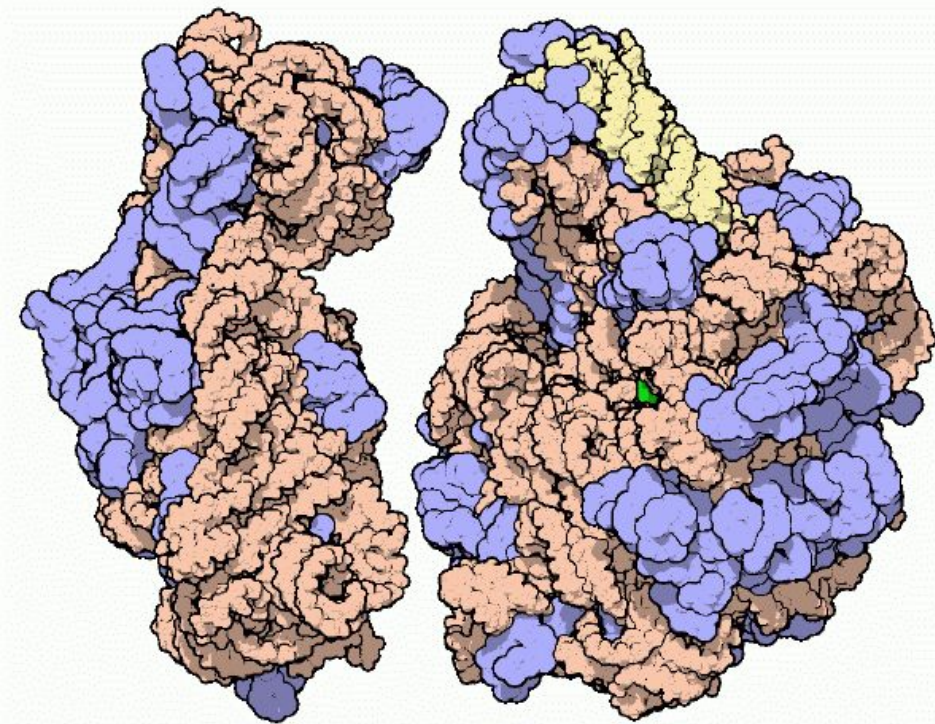

The Ribosome

Threshold Theorems

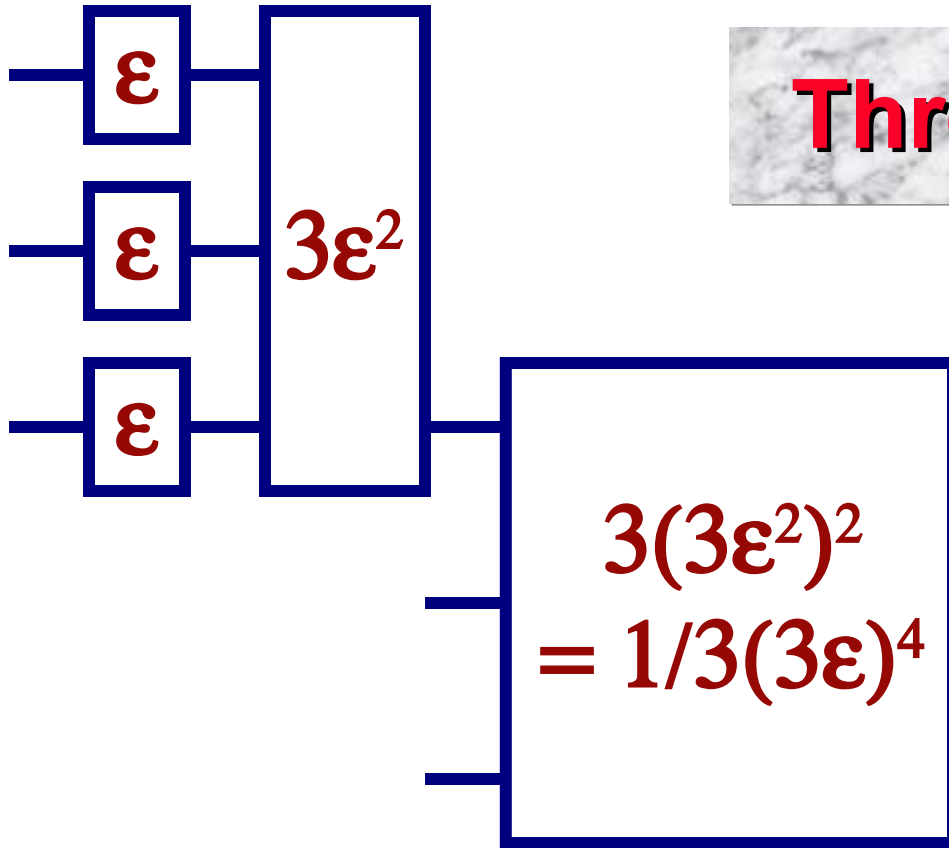

•
•
•

$$3^n$$

•
•
•

$$1/3(3\epsilon)^{2n}$$

Thresholds

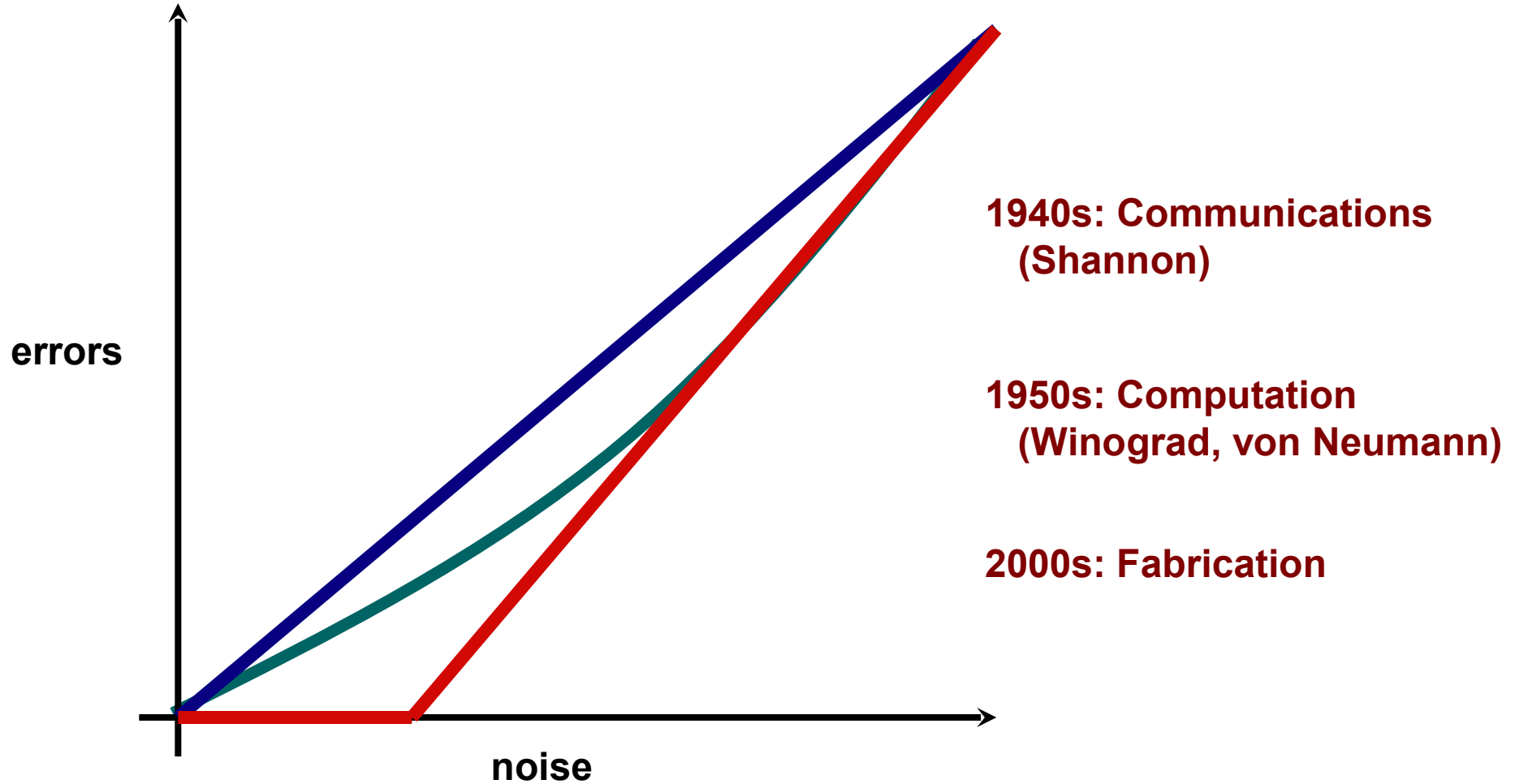

Theory of Self-Reproducing Automata

JOHN VON NEUMANN

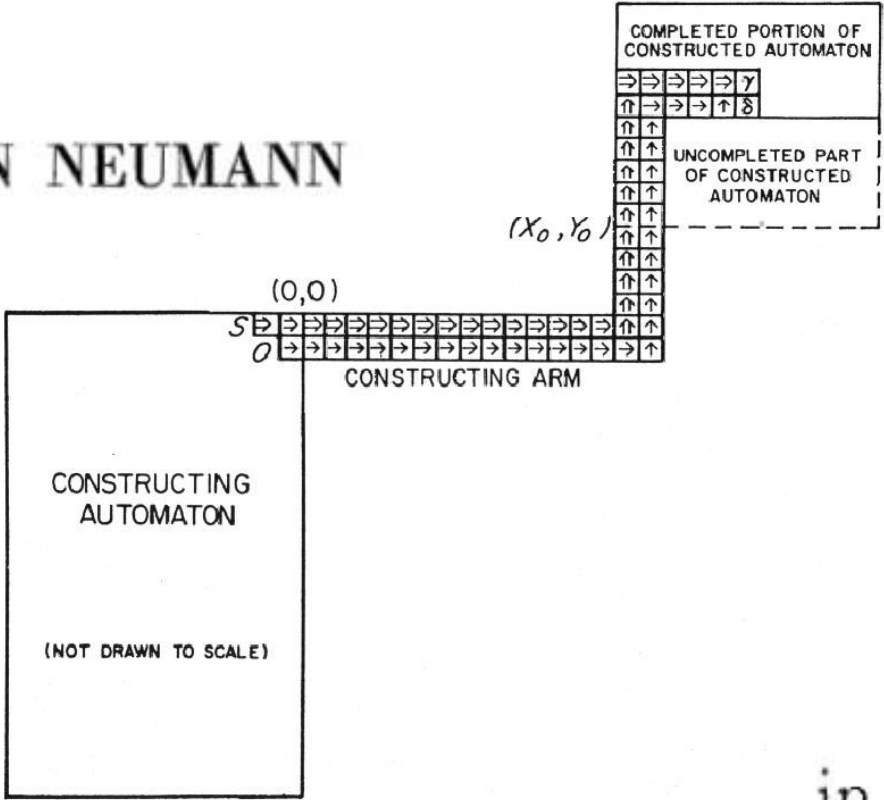

Fourth Lecture

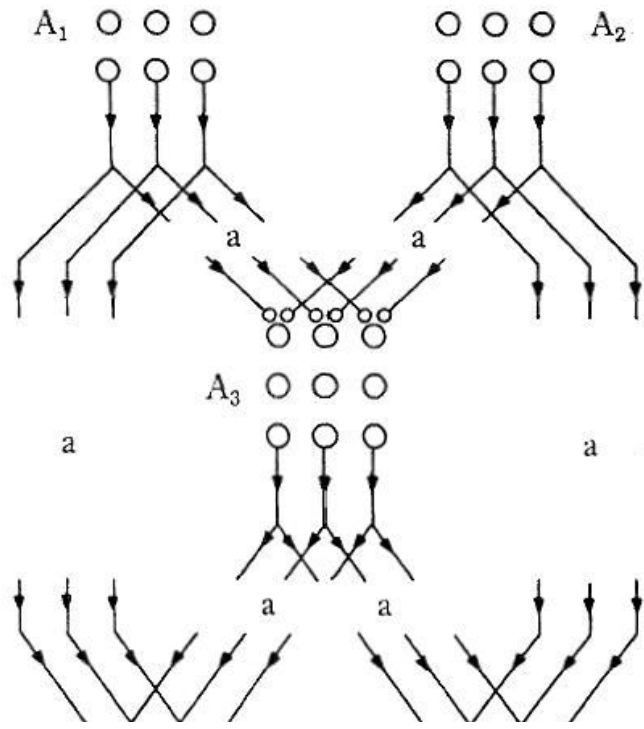

Reliable Computation
in the Presence of Noise

THE ROLE OF HIGH AND OF
EXTREMELY HIGH
COMPLICATION

S. Winograd and J. D. Cowan

in

out

m



mm



μm



nm

How To Make (almost) Anything

Date	Subject
9/10	Design Tools, Input Devices
9/24	Machining
10/1	3D Printing, NC machining
10/15	Laser, Water Jet, NC Knife Cutting
10/22	Materials and Finishes
10/29	Forming and Molding
11/5	Basic Electronics
11/12	ECAD
11/19	Sensor Technology
11/26	Programmable Logic
12/3	Microcontrollers
12/10	Wired & Wireless Communications

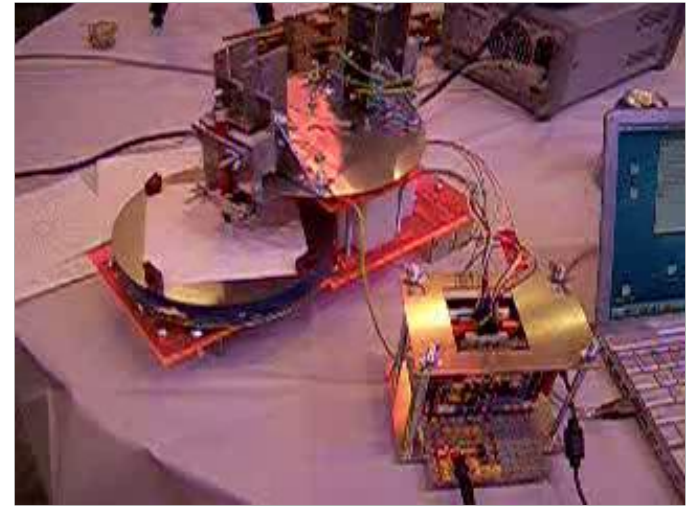
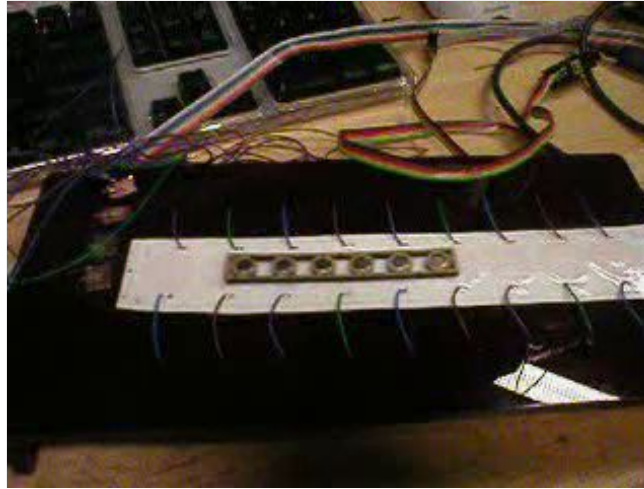



← NC router →
plasma cutter

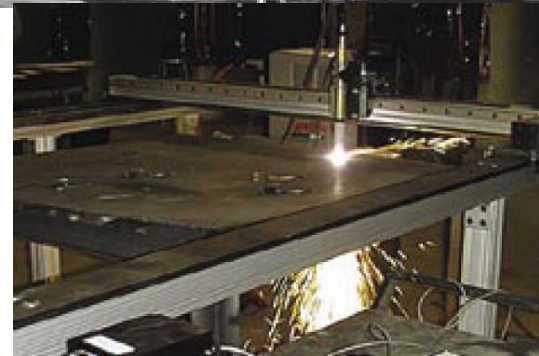

Firefox
 File Edit View Go Bookmarks Tools Help
 https://fab.cba.mit.edu:14592/

logout

parent directory: /srv/content/projects/comm view

current directory: /srv/content/projects/comm/antennas

create directory:

child directories:

axial_array_specs view delete move: copy:

cad_files view delete move: copy:

links view delete move: copy:

Photos view delete move: copy:

planar_array_specs view delete move: copy:

presentations view delete move: copy:

tools view delete move: copy:

tutorials view delete move: copy:

create file: (.html for Web)

upload file: Browse... upload (.zip for archive)

current directory contents:

antennas.css edit download delete move: co

index.html edit download delete move: copy:

stbserver+git: 1/3/07

FAB LAB Antennas - Firefox
 File Edit View Go Bookmarks Tools Help
 http://fab.cba.mit.edu/content/projects/

FAB LAB
 fab.cba.mit.edu

Tools for connecting people

Fab Lab Antenna Projects
 fab.cba.mit.edu





photos cad_files tutorials presentations links

Glass Antennas
 Starting from a wideband dipole to four element arrays, mostly for indoor coverage.

Higher Gain Arrays
 New Planar design with glass substrate and ground plane reflector for outdoor links up to 20 km.

Measuring Tools
 Tools and guides to start up a link. Projects under development to measure SWR of antennas and transmission lines.

Low Cost - Intelligent Design

- Modular concept to satisfy most of the needs
- High, medium or low gain
- Omni directional or directional characteristics
- Input Impedance 50 Ohm
- Large Bandwidth around 2.4 GHz, VSWR -2
- Fabrication faults tolerant
- Mechanical rigidity
- Weather resistant



proposed by George Sergiadis

Done

**Ghana, South Africa,
India, Costa Rica,
Boston, Norway, ...**

Fab Labs



***fabrication and
instrumentation divide***



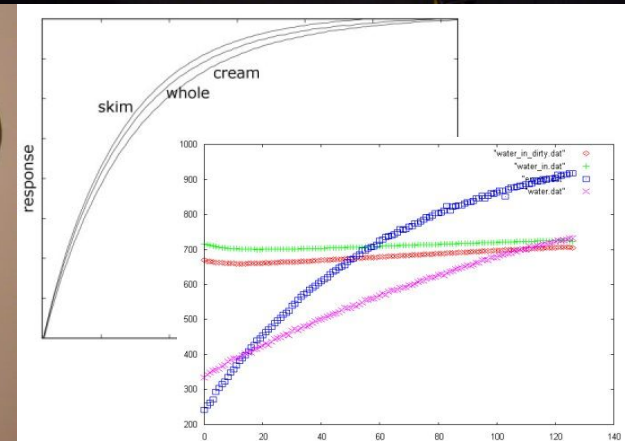
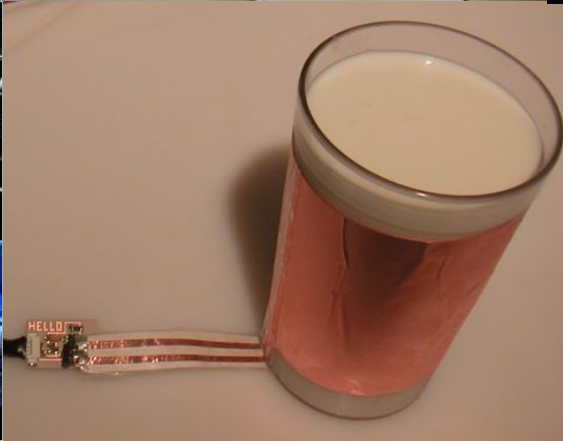
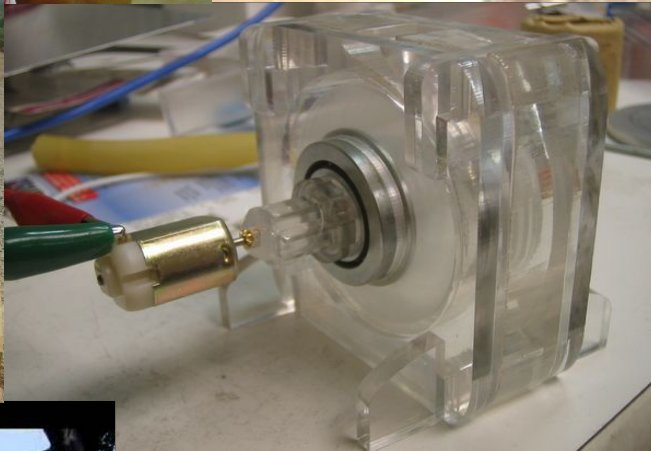



The Third International
Fab Lab Forum
and
Symposium on Digital Fabrication

Pretoria, South Africa
June 29, 2006



science
& technology
Department:
Science and Technology
REPUBLIC OF SOUTH AFRICA

amts
advanced manufacturing
technology strategy

CSIR
our future through science

9:00-9:30 **Introduction**

Neil Gershenfeld
CSIR, AMTS, DST

9:30-10:45 **Foundations**

Charles Bennett: *molecular machines*
Joe Jacobson: *fabricational complexity*
Saul Griffith: *programmed assembly*
Paul Rothemund: *DNA origami*
Erik Winfree: *algorithmic self-assembly*
Hod Lipson: *machines that make machines*

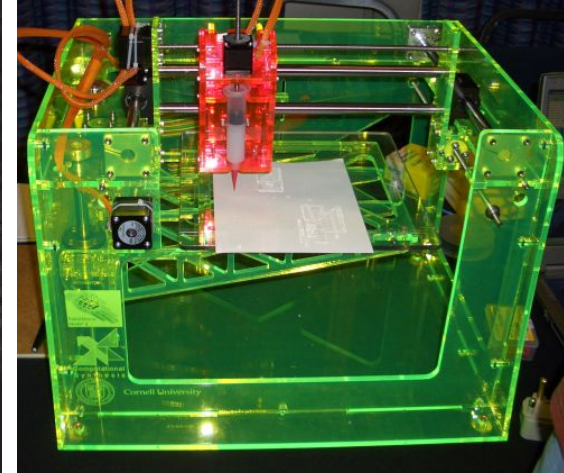

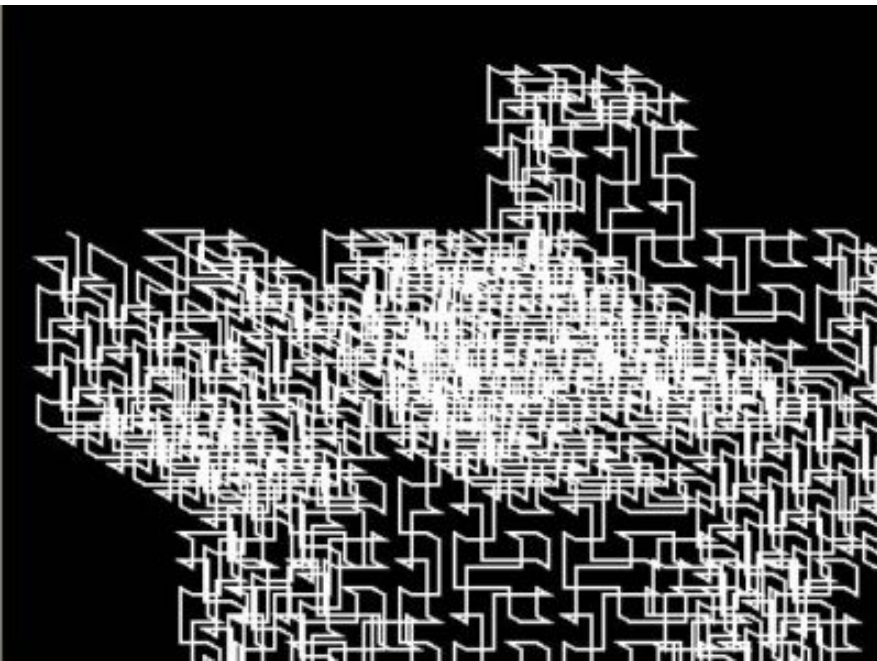
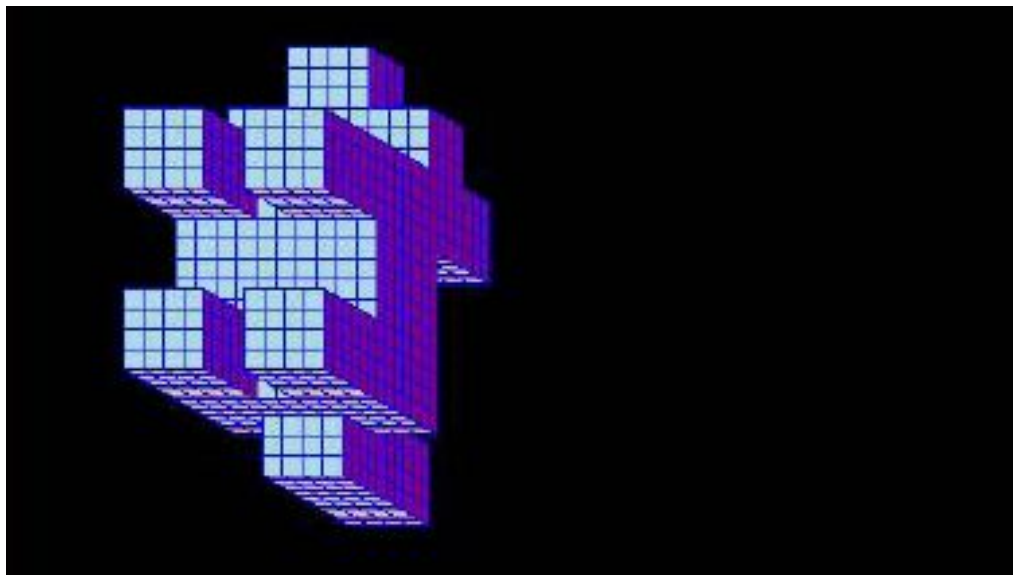
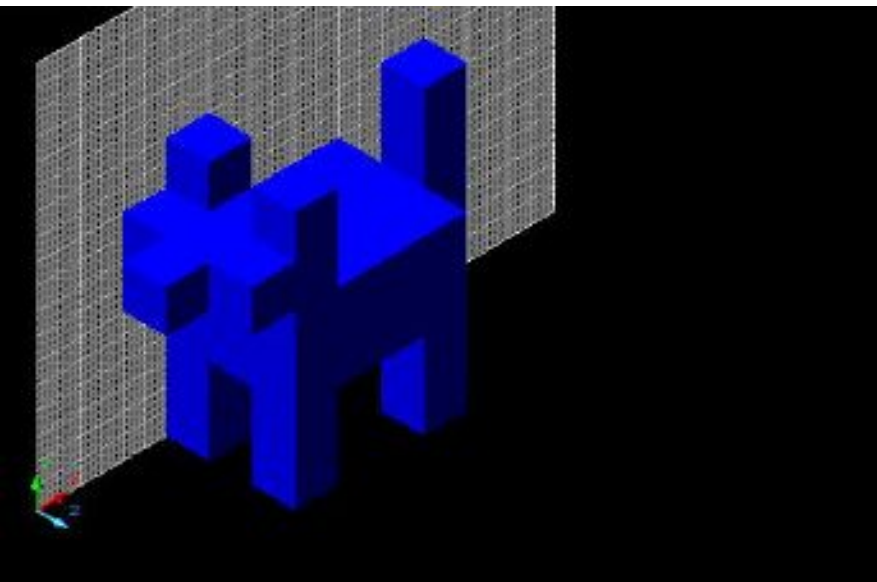

!172142747174171271741721241217214247427417212412717471741712172142747174171217212412717417
!41271474247242124127147424724212412171271741712717417214247242142472421427471412412714742
!121721427471472421241271474247242124127147424724212412714124127174172124127141427414127141
!14274714124121721424727272412714142741412717471474274714124121721241271474274714742741712
!172124127174717417214247241217212412717471472412172124121412172124121721241217214247241271
!274714724214274717121712172127212412171217214274717417212412714742472421241217121721427471
!4742472421242142747147427471474274717212412172124121712714742747147424724272427272
!417214247424142741421272727214274714724121421241271474274171271414247241217214274717414214
!17127147242727121712714724214274714724272712717417274247242124127147424742472421241271474
!72142474274172124127174717417214241241214121721427471412412714742741727272124121712172724
!474274141217127147242142747141427417272727242142747147427471474274717121721427471472427424
!724214247241217212412714742747174717471741712714742741421242142472412172124212412712142412
!241217214274714742747141241217212412714742747147427417127147242727272412172724121721241217
!4127141427471472412141217214274717414121721241271474274717471472412172124121727242742747172
!214247424724214274717417127174171271747147241217127174172124127174171214212421424724214274
!14247242142741712717417214247242142741712717417214247242142741712717417214247242142741712
!2421427417127174172142472421427417127174172142472421427417127174172142472421427417127174172
!274171271741721424724214274171271741721424724214274171271741721424724214274171271741721424
!127174172142472421427417127174172142472421427417127174172142472421427417127174172142472421
!417214247242142741712717417214247242142741712717417214247242142741712717417214247242142741
!424724214274171271741721424724214274171271741721424724214274171271741721424724214274171271
!421427417127174172142472421427417127174172142472421427417127174172142472421427417127174172
!74171271741721424724214274171271741721424724214274171271741721424724214274171271741721424
!27174172142472421427417127174172142472421427417127174172142472421427417127174172142472421
!172142472421427417127174172142472421427417127174172142472421427417127174172142472421427417
!247242142741712717417214247242142741712717417214247242142741712717417214247242142741712717
!214274171271741721424724214274171271741721424724214274171271741721424724214274171271741721
!417127174172142472421427417127174172142472421427417127174172142472421427417127174172142472
!717417214247242142741712717417214247242142741712717417214247242142741712717417214247242142
!72142472421427417127174172142472421427417127174172142472421427417127174172142472421427417
!472421427417127174172142472421427417127174172142472421427417127174172142472421427417127174
!142741712717417214247242142741712717417214247242142741712717417214247242142741712717417214
!171271741721424724214274171271741721424724214274171271741721424724214274171271741721424724
!174172142472421427417127174172142472421427417127174172142472421427417127174172142472421427

(Kenneth Cheung)

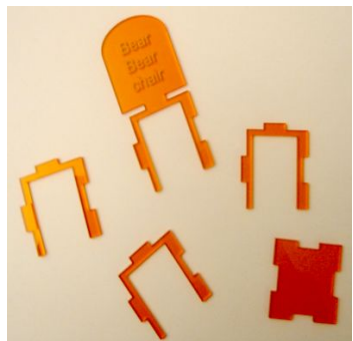
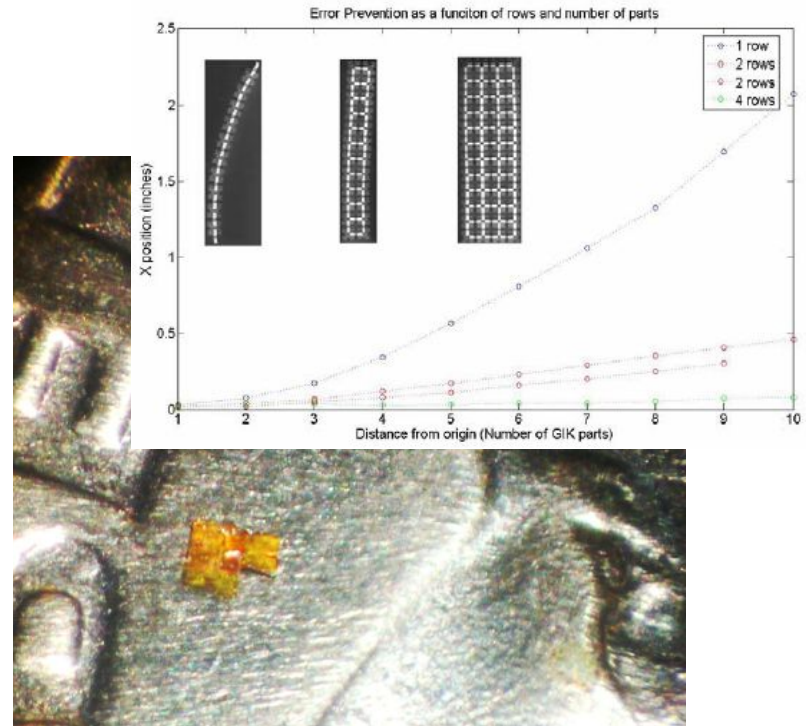

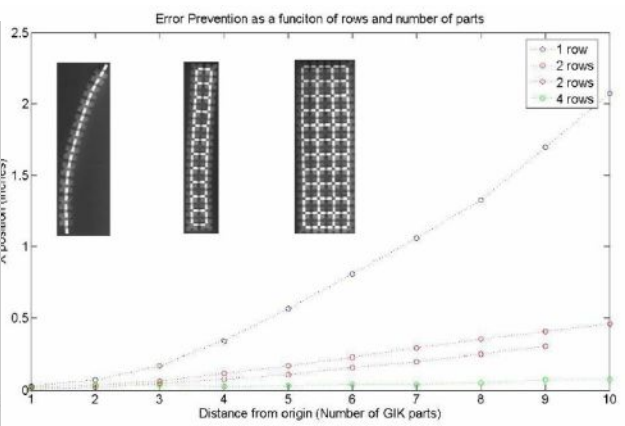
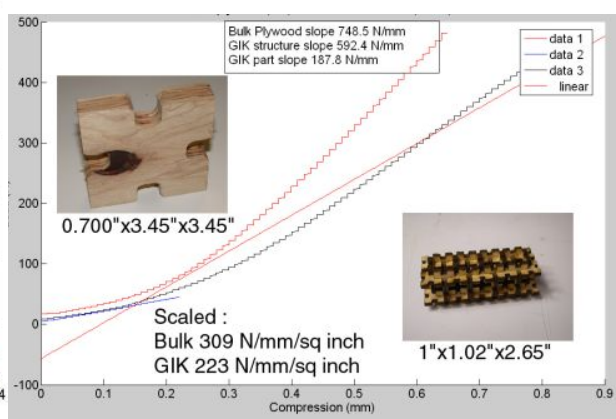
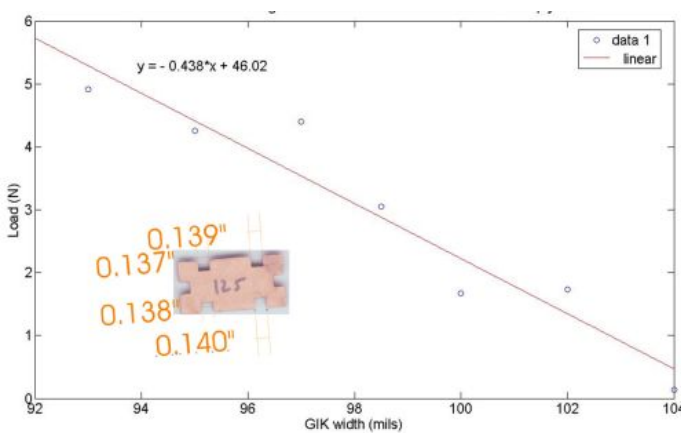
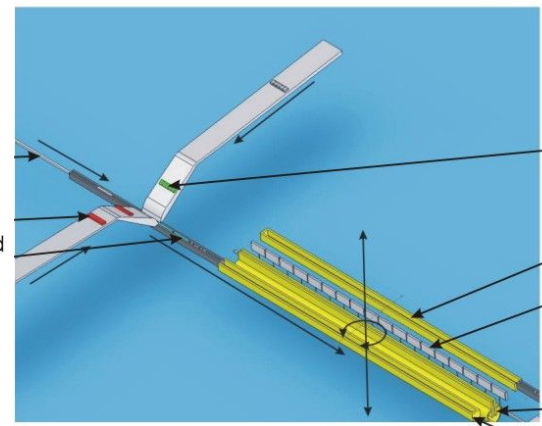
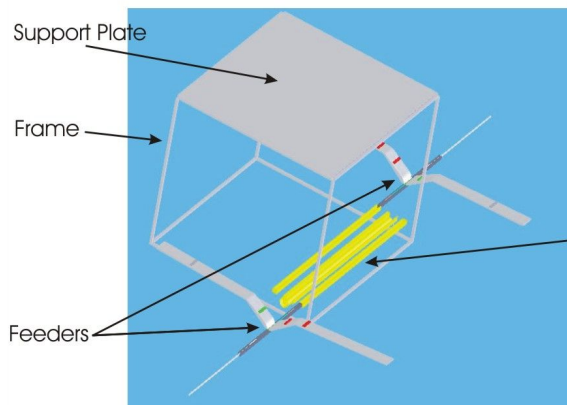
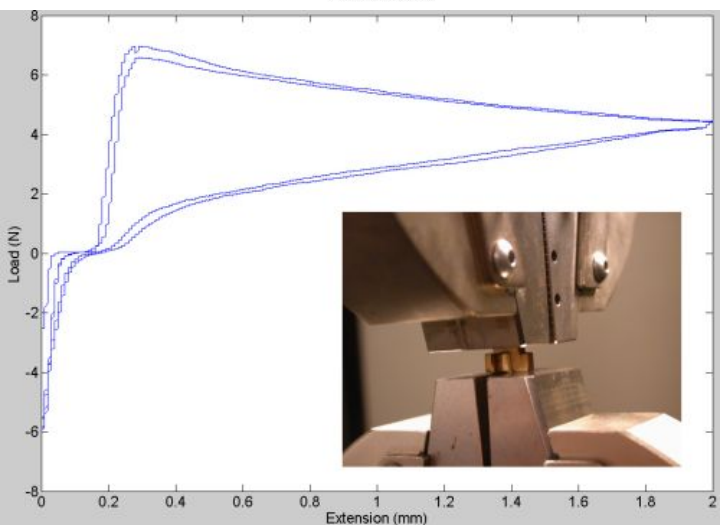
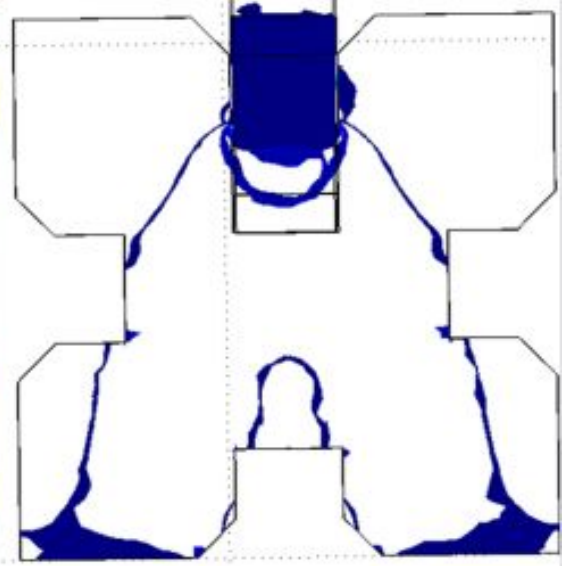
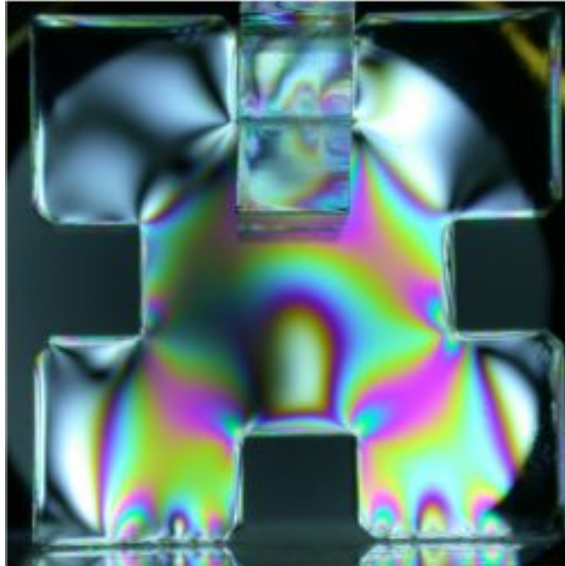
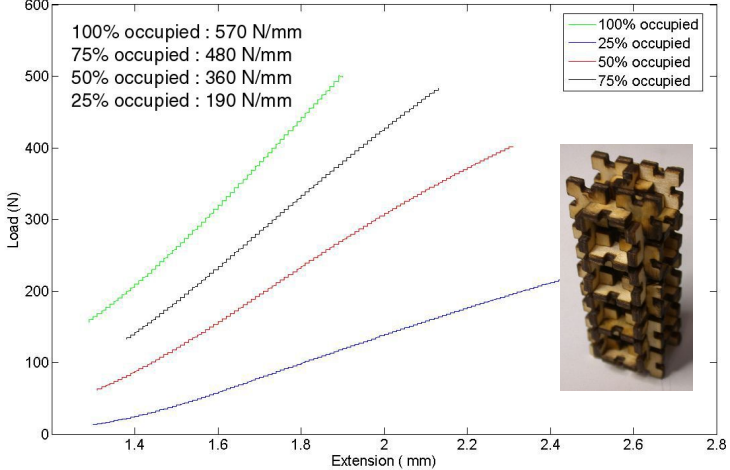

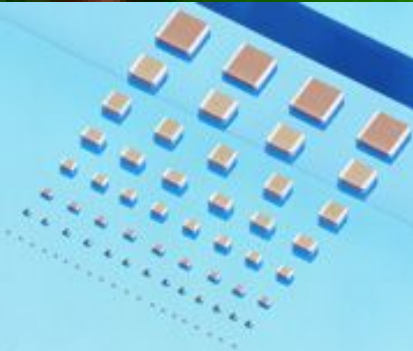
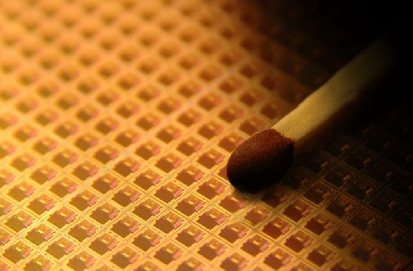

Roll-to-Place?

Digi-Key Part Number	311-1.0KGTR-ND	Price Break	Unit Price	Price
Manufacturer Part Number	9C06031A1001JLHFT	5000	0.00330	16.50
Description	RES 1.0K OHM 1/10W 5% 0603 SMD	10000	0.00297	29.70
Quantity Available	<input type="text" value="0"/> <input type="button" value="Enter Quantity Requested"/>	25000	0.00264	66.00
		50000	0.00220	110.00
		100000	0.00183	182.60
		250000	0.00165	412.50
		500000	0.00149	742.50
All prices are in US dollars				

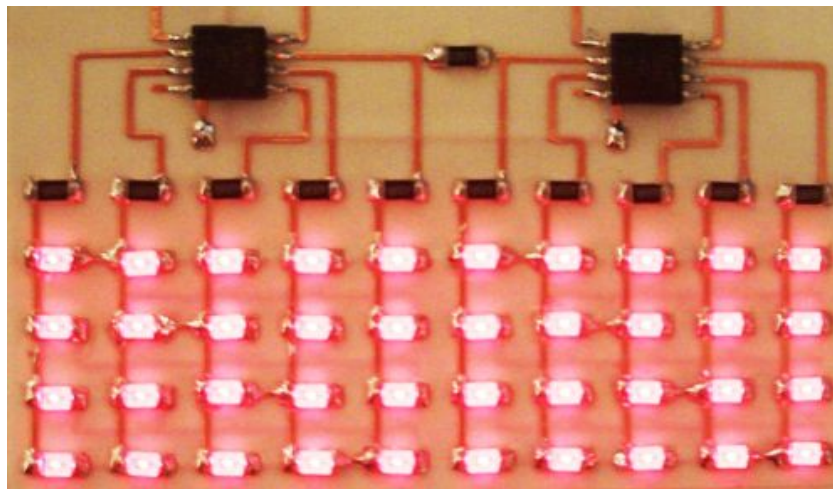

Microfluidic Bubble Logic

M. Prakash and N. Gershenfeld,
Science 315, pp. 832-835 (2007)

